

選手権男子本戦

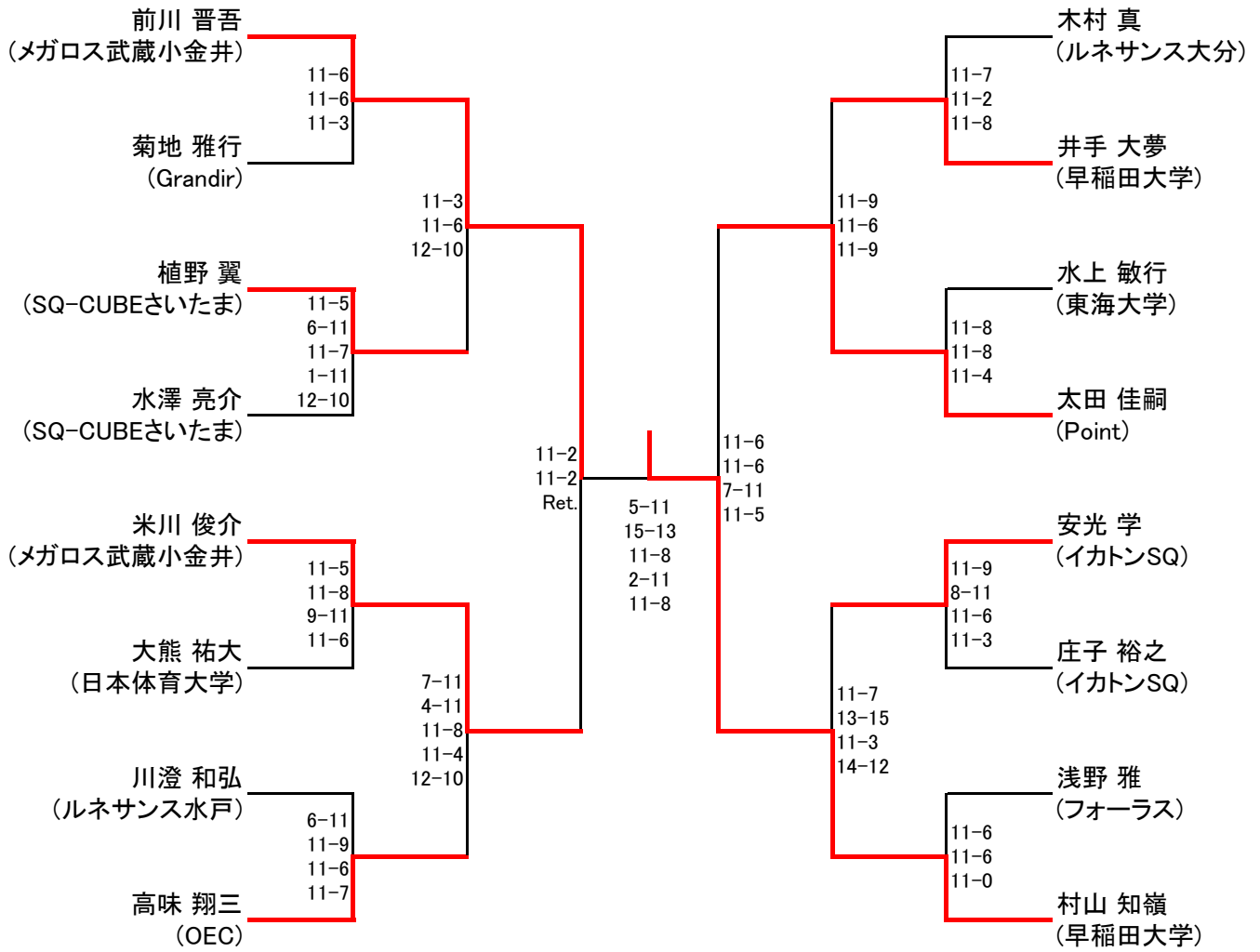

選手権女子本戦

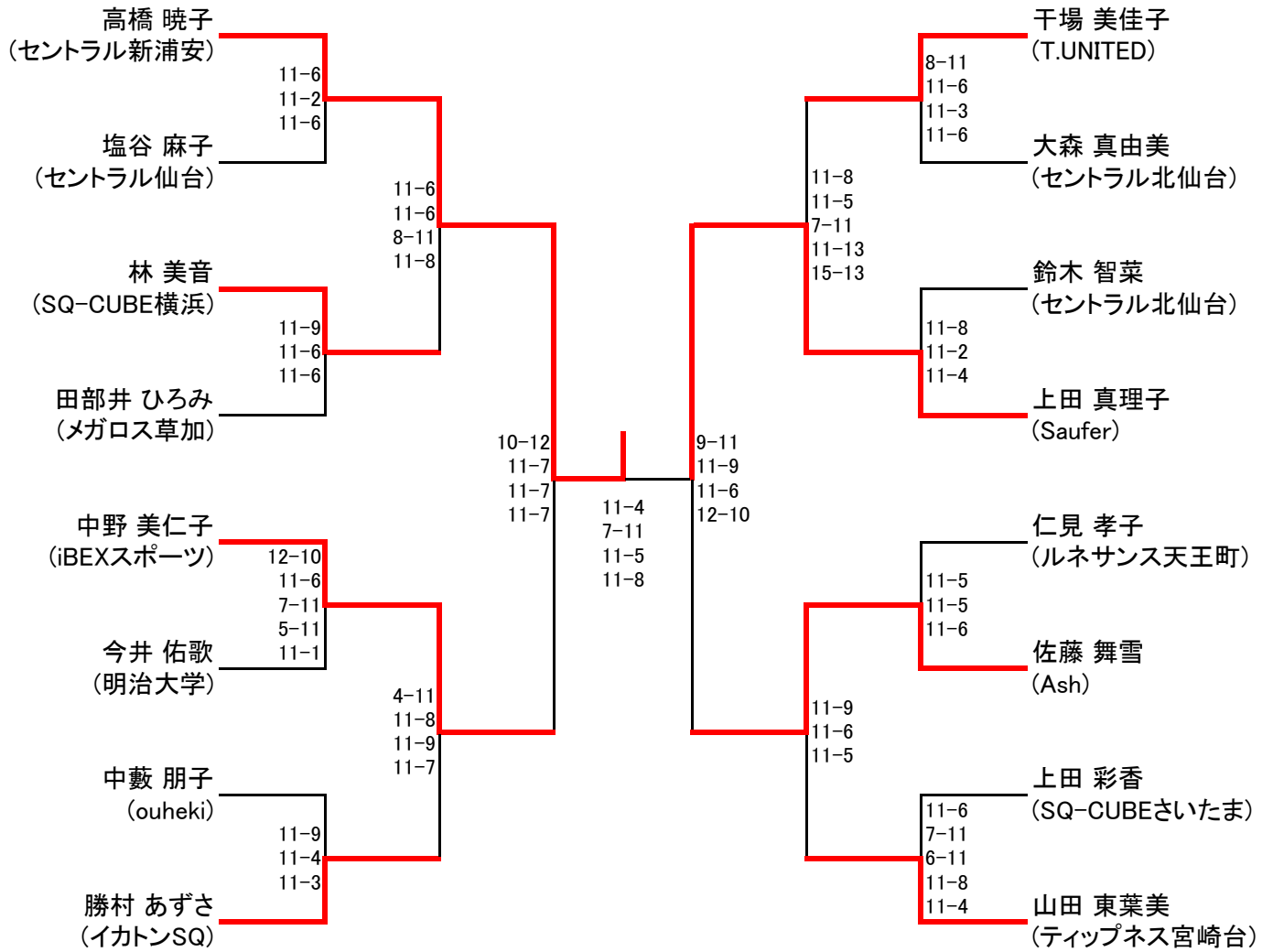

選手権男子予選

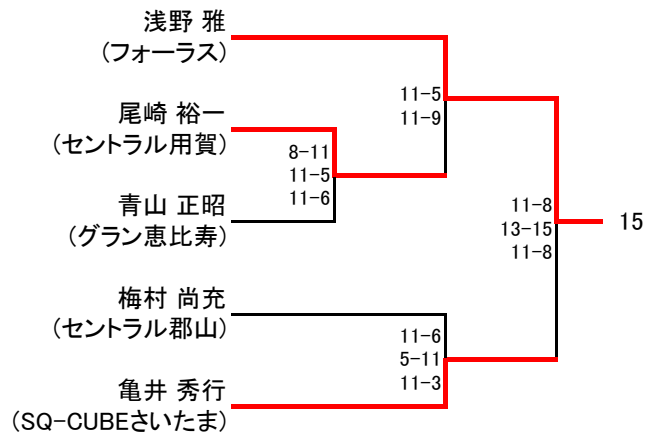
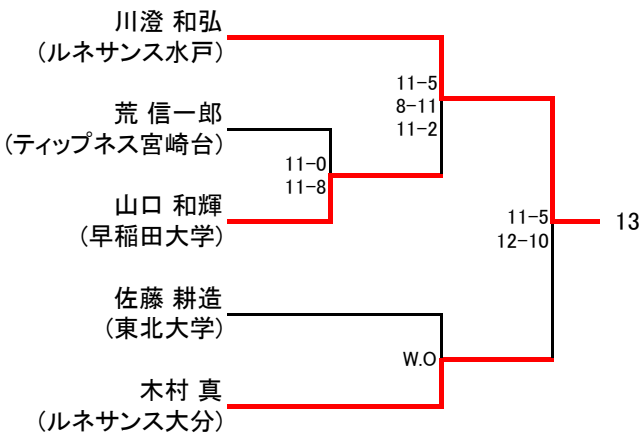
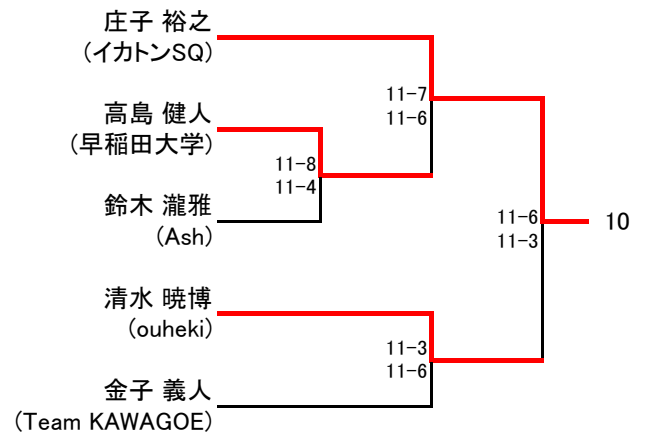
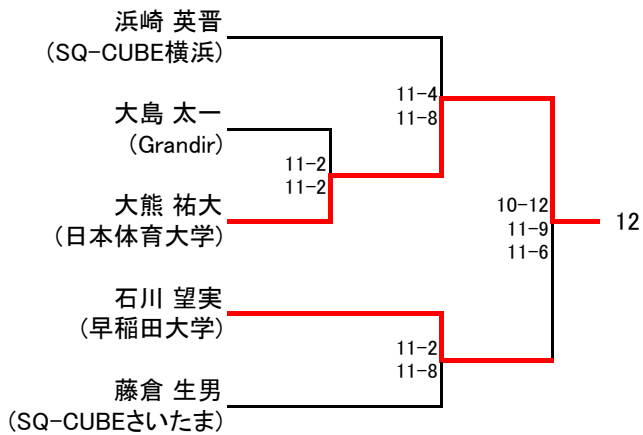
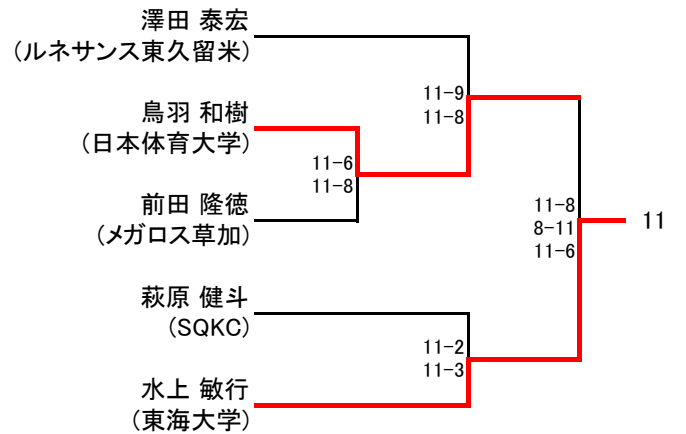
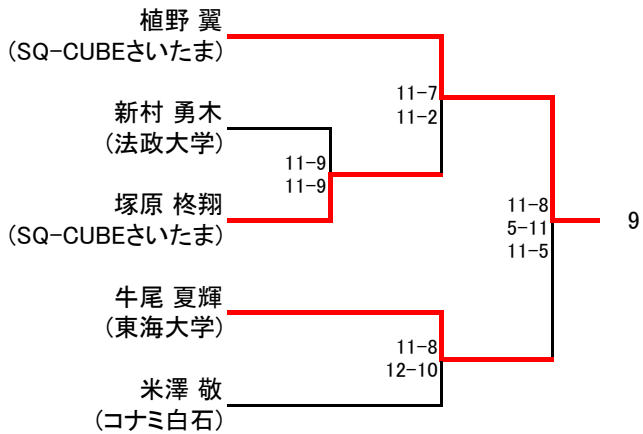
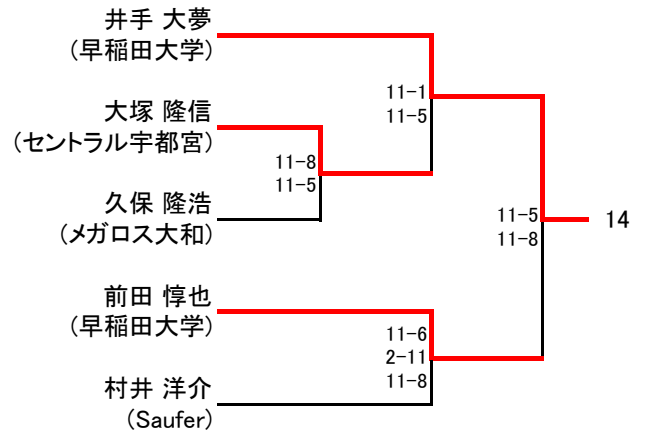
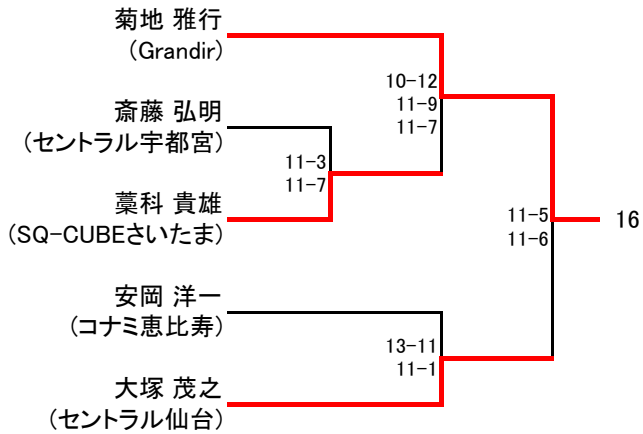

選手権女子予選

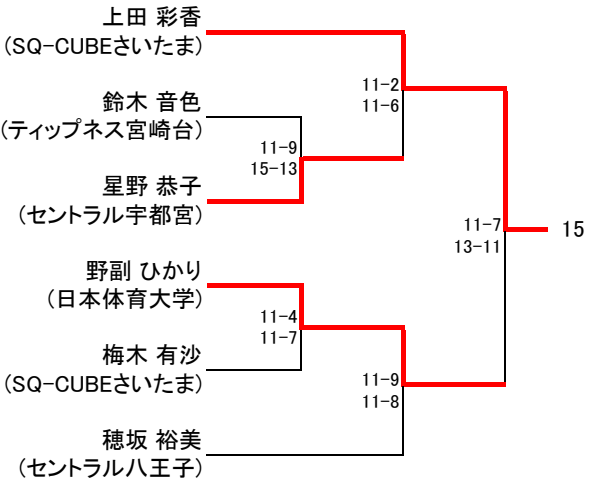
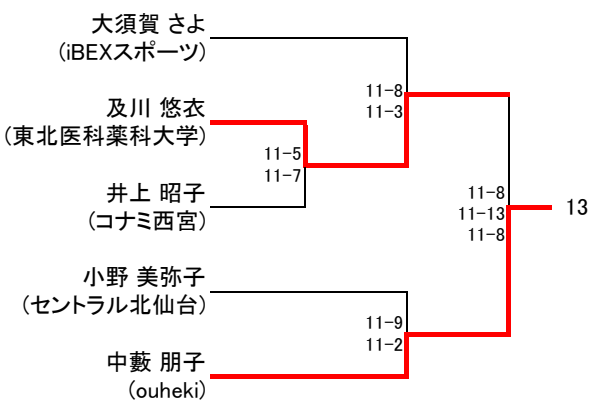
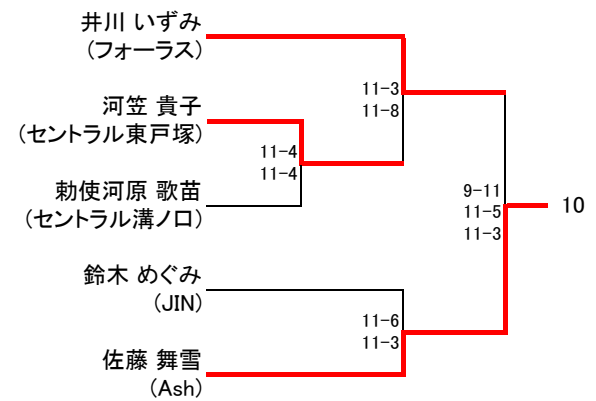
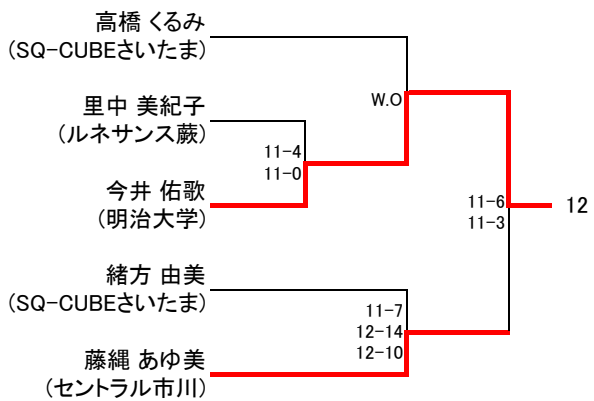
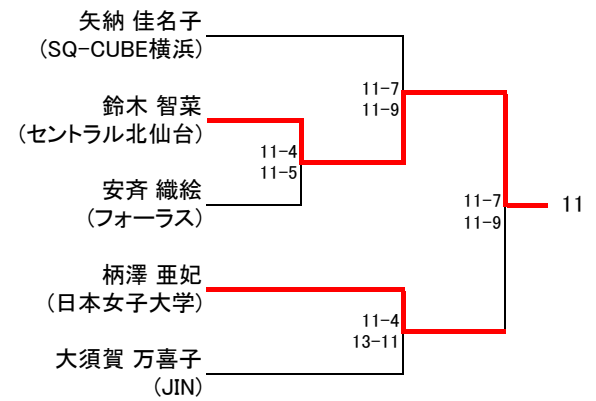
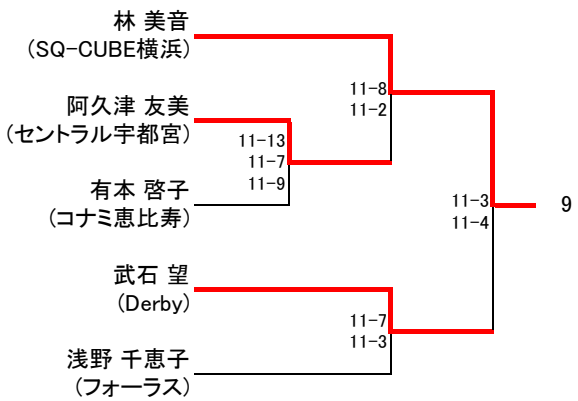
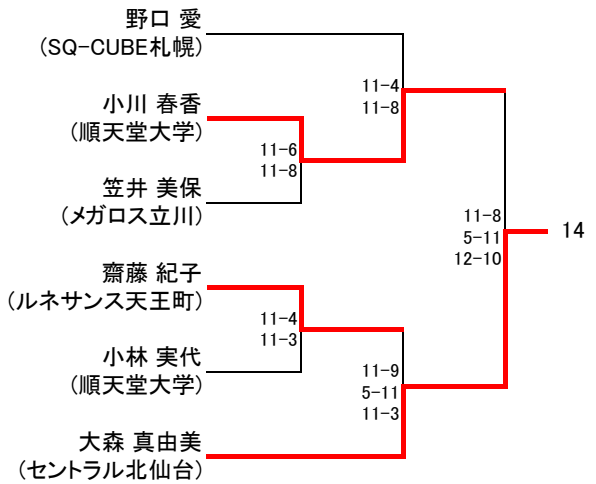
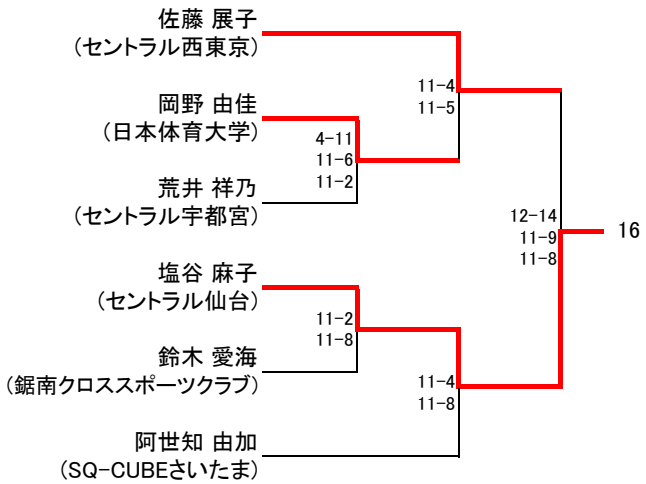

フレンド男子A

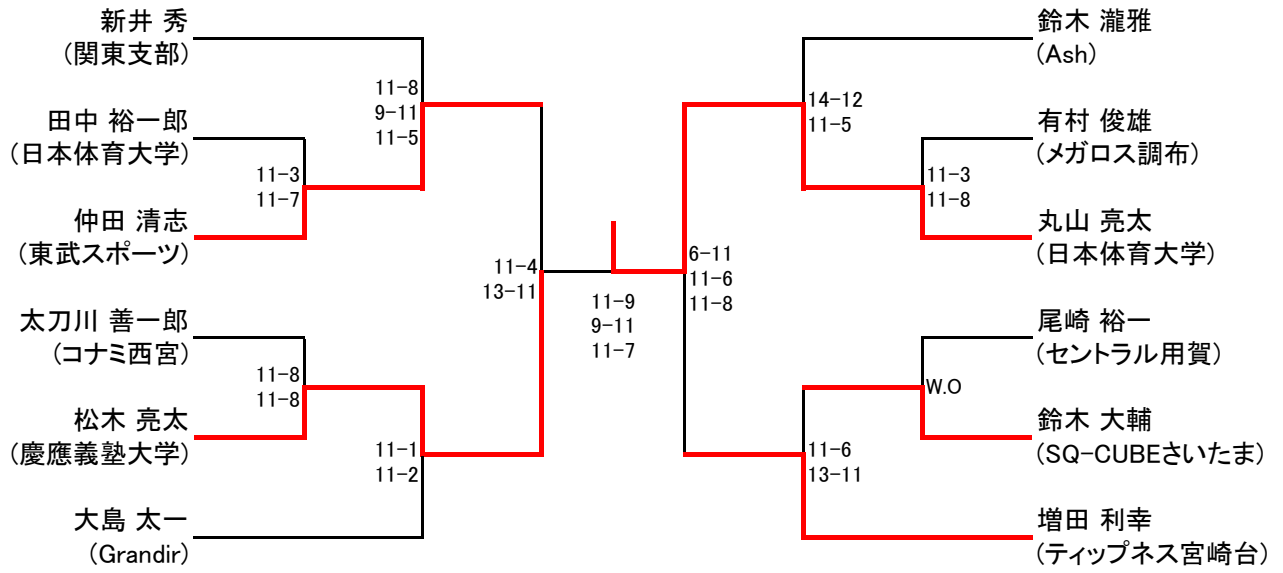

フレンド女子A

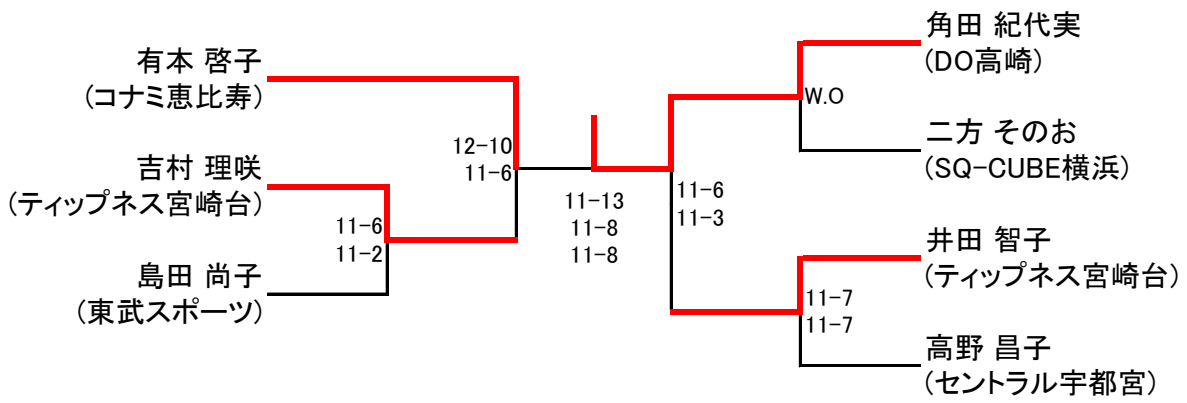

フレンド男子B

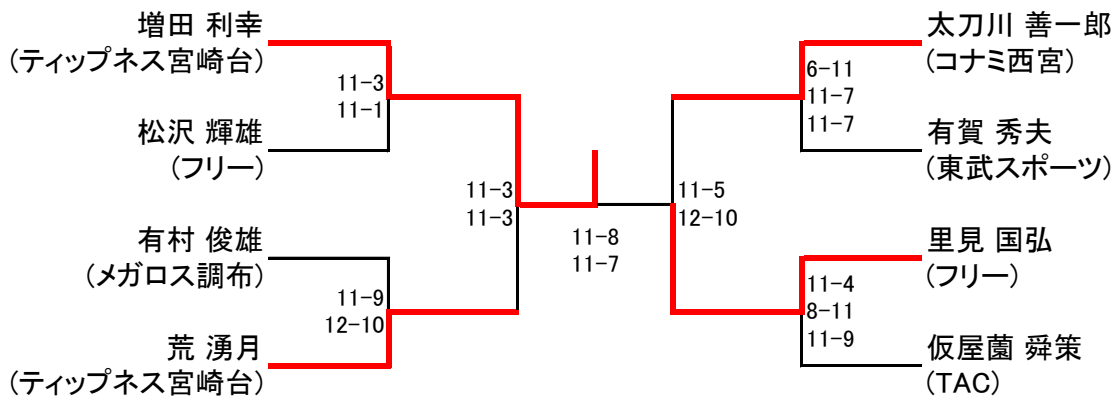

フレンド女子B

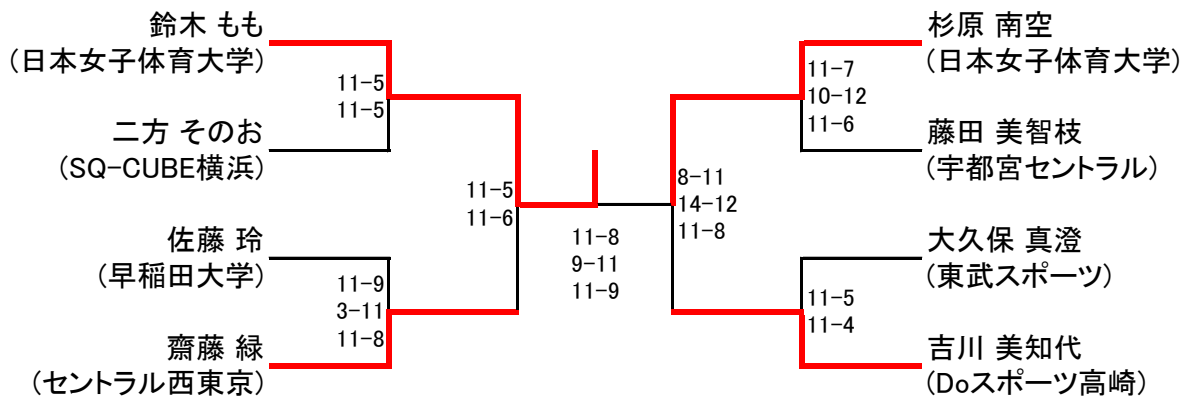

新人男子

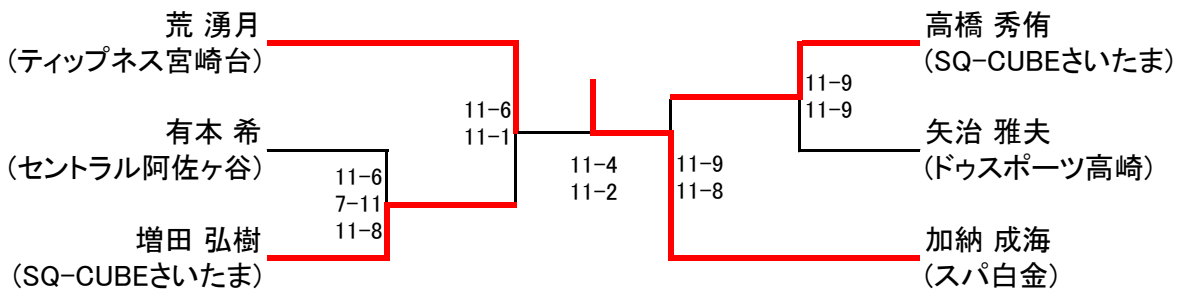

新人女子

	石川 みはる	根岸 美由樹	山室 心泉	村尾 トシ江	順位
石川 みはる (Big Mouth)		○	○	●	2
		11 11 2	11 11 2	4 10 0	
		6 5 0	9 3 0	11 12 2	
根岸 美由樹 (ルネサンス蕨)	●		●	●	4
	6 5 0		4 6 0	11 7 2 1	
	11 11 2		11 11 2	5 11 11 2	
山室 心泉 (SQ-CUBEさいたま)	●	○		●	3
	9 3 0	11 11 2		6 9 0	
	11 11 2	4 6 0		11 11 2	
村尾 トシ江 (ドゥスポーツ高崎)	○	○	○		1
	11 12 2	5 11 11 2	11 11 2		
	4 10 0	11 7 2 1	6 9 0		